

Marine Yacht

MTU Generator Sets



Power. Passion. Partnership.



MTU Gensets

MTU. Generating power.

MTU gensets form the centerpiece of marine propulsion and onboard power generation. Our gensets breathe life into every yacht and go beyond expectations in carrying out their demanding task.

MTU's advanced and premium gensets are specifically engineered to provide you with the highest level of comfort, reliability, cost-efficiency, safety and flexibility. As your systems supplier, MTU builds gensets for propulsion, onboard power generation and emergency power that fit your individual demands exactly.

Comfort
Reliability
Efficiency
Safety
Flexibility

Solutions for your power at sea.

MTU gensets are based on MTU Series 60, 1600, 2000 and 4000 engines. Whether you are looking for onboard power, diesel-electric or hybrid propulsion, MTU gensets meet the full spectrum of your requirements.

MTU's advanced and premium gensets are available as a constant speed version in 50 or 60Hz or as a variable speed configuration with added electronics. The sound enclosure and base frame can be specifically tailored to meet your acoustic needs, and the integrated plug-and-play media plate ensures convenient mounting.

MTU also provides emergency gensets for critical situations at sea, when absolute reliability is essential. In addition to gensets for main propulsion and onboard power, MTU also supplies lower-power gensets which can be installed as separate power units in the engine room.

MTU's genset portfolio covers power outputs from 5 to 3,480 kWe.

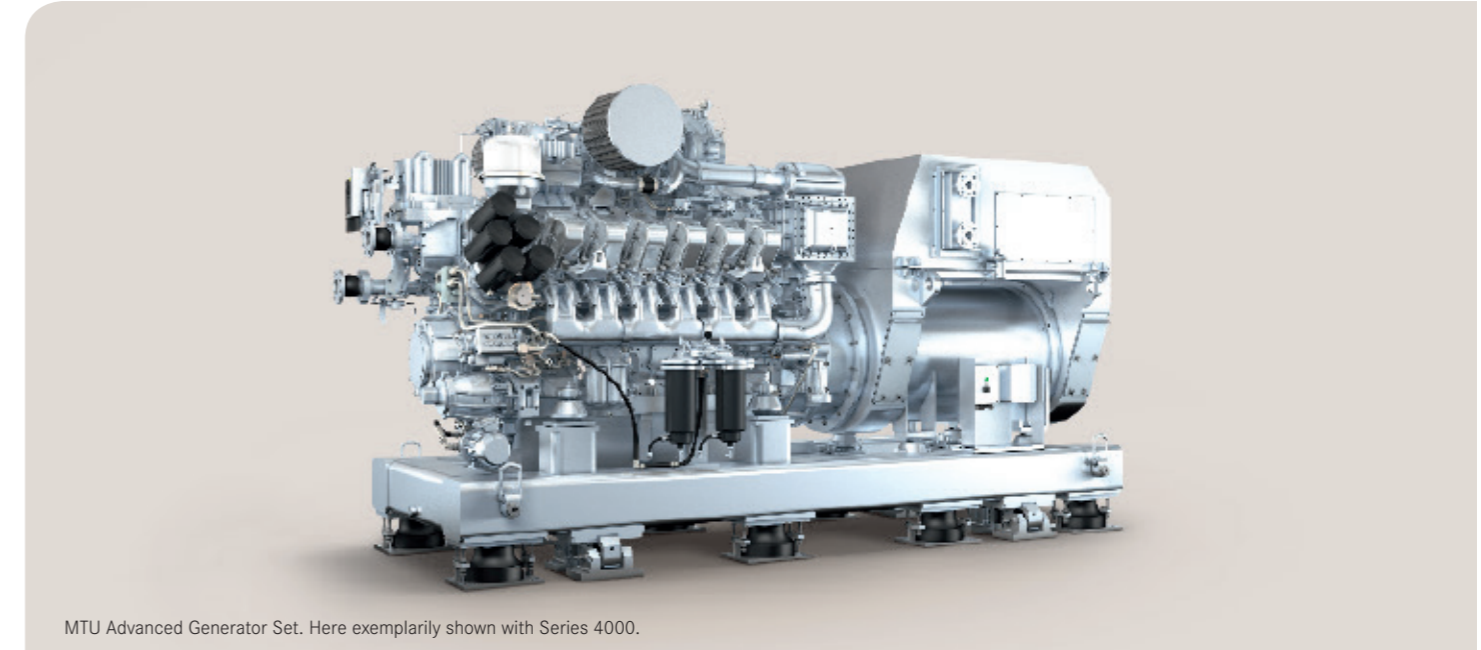

MTU Advanced Generator Set. Here exemplarily shown with Series 4000.

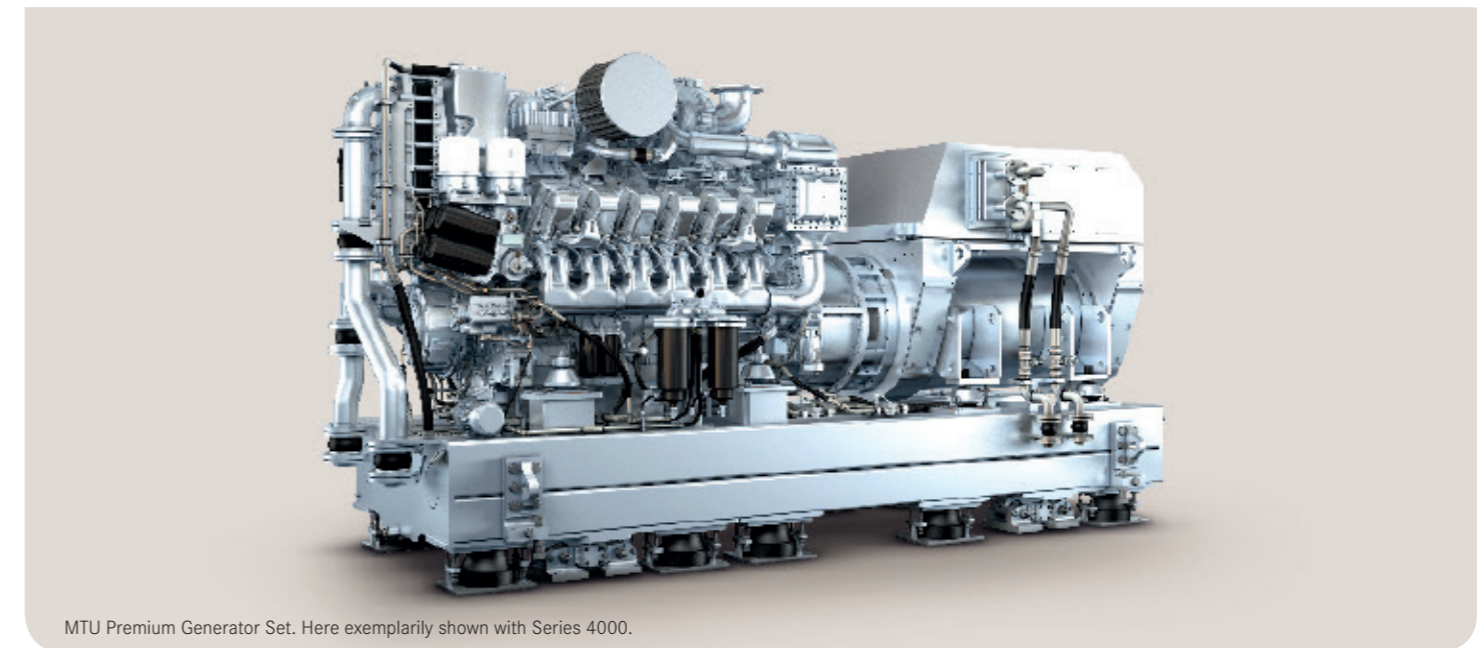
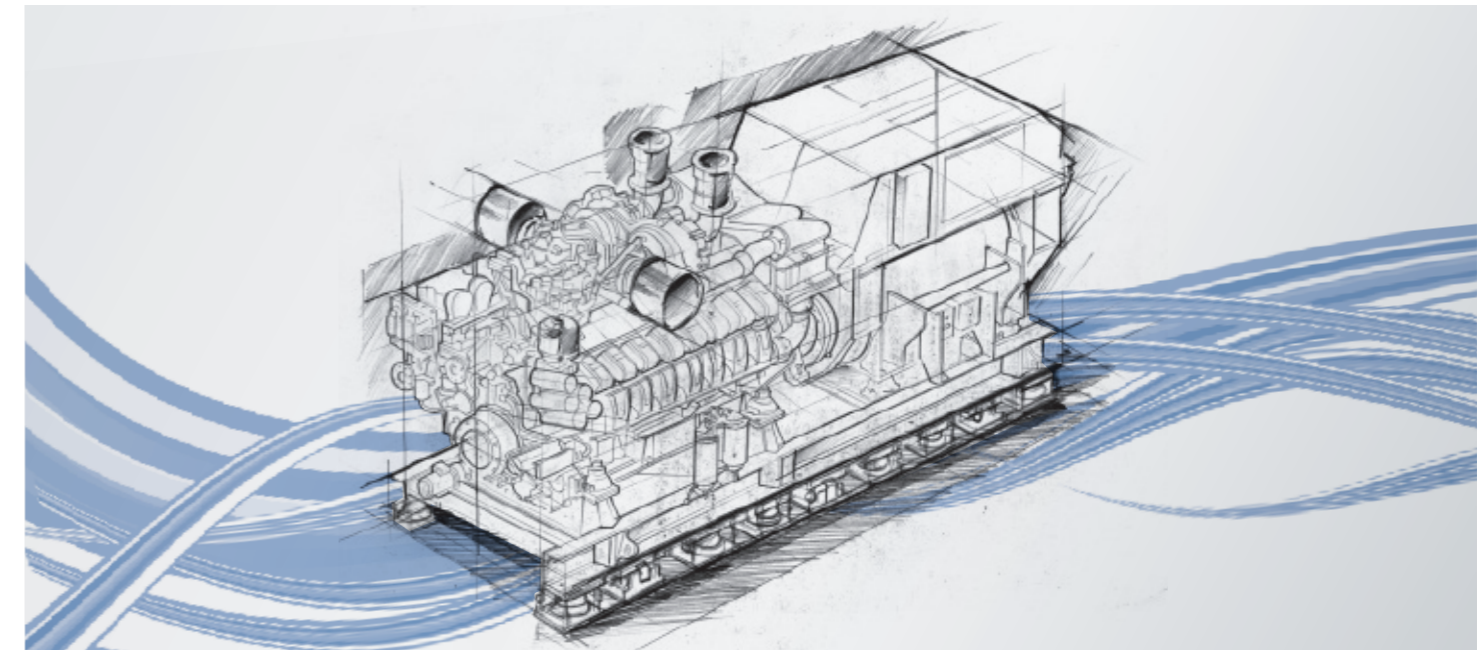

MTU Premium Generator Set. Here exemplarily shown with Series 4000.

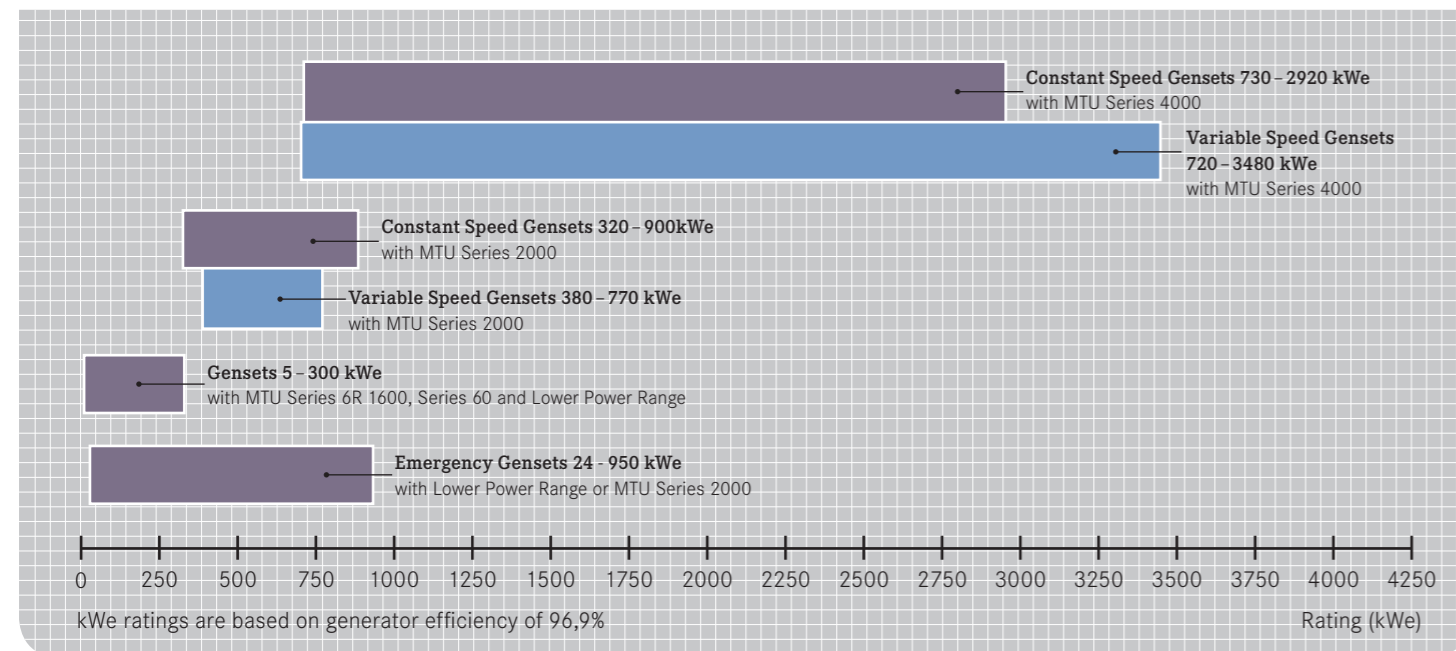



Electrical Power for Onboard Consumers

Reliable onboard power.

Whenever you need electrical power for your onboard consumers, just relax while your MTU gensets do their job. MTU gensets provide the highest degree of comfort and reliability to ensure you a carefree stay on-board.

MTU offers a wide range of genset configurations for onboard power to satisfy the most stringent requirements in terms of acoustics, reliability in all situations and cost-effectiveness.

Comfort

Reliability

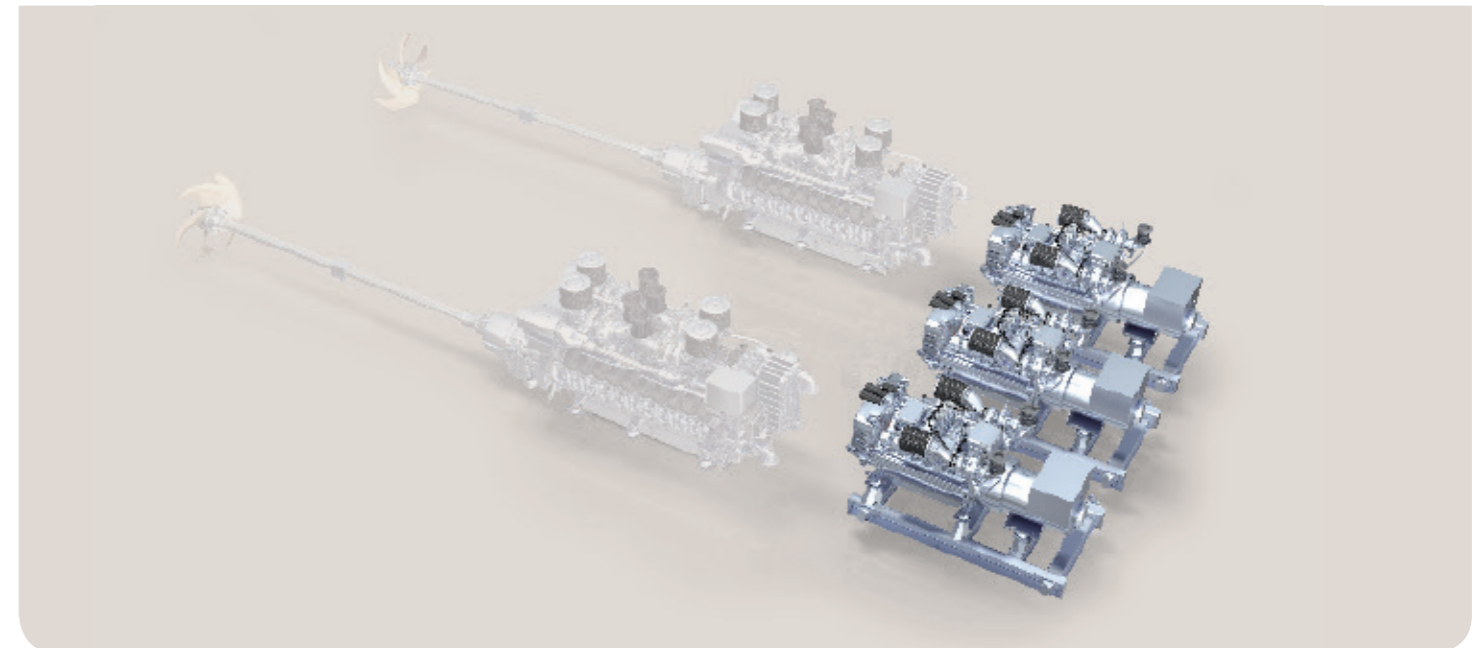

Electrical Power for Propulsion and Onboard Consumers

Power for your comfort.

Do you want to cruise quietly and comfortably? MTU's power source guarantees a pleasurable stay on-board.

MTU supplies complete gensets for connection to your power supply system to provide both marine propulsion and electrical power for your onboard consumers. Our combination of propulsion and onboard power guarantees cost-efficient cruising and an enjoyable life on deck.

Comfort

Reliability

Efficiency

- 1 Gensets
- 2 Switchboard
- 3 Electric Motor

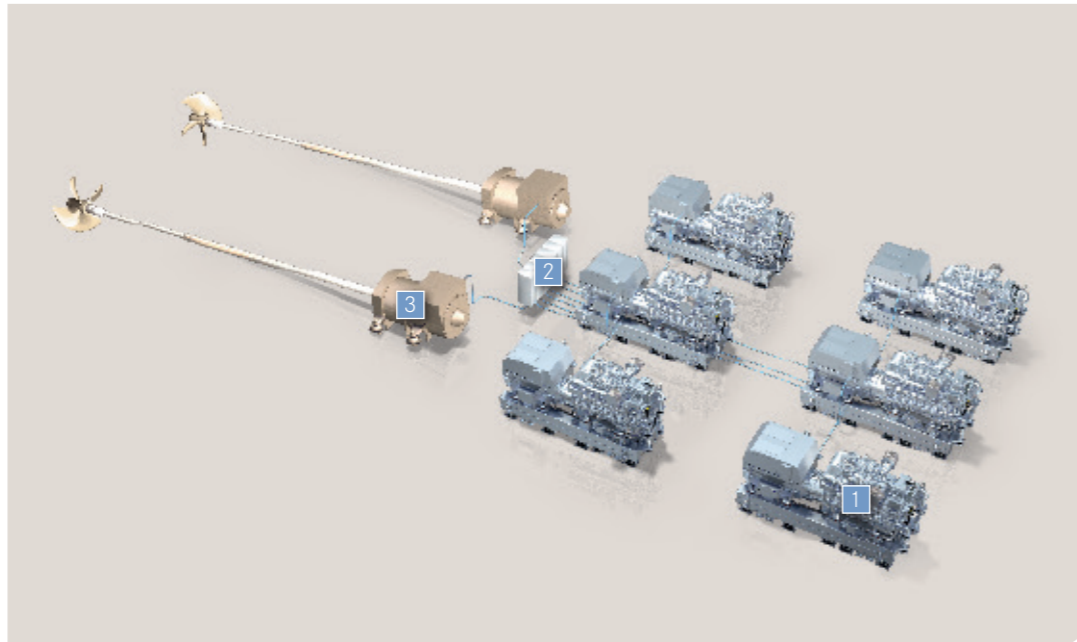



E-Drive Hybrid Solutions

Your unique system for cost-efficient power.

Our innovative, cost-efficient hybrid systems are fit for the future and are built with a high level of system redundancy for extra comfort and safety.

Conventional propulsion systems can be enhanced using extra power from electrical motors. Supported by battery modules, even emission-free silent running with a combination of battery power and electric motors is possible. The electric motor can be deployed for Power Take-In (PTI) via an input at the gearbox. With the gensets off-line, it can be used as an alternator at Power Take-Off (PTO)

to provide cost-effective power for your hotel load. Connecting an exhaust gas aftertreatment system to the gensets caters for eco-friendly yacht maneuvering in harbor areas.

Your benefits are:

- Enhanced drive dynamics
- Lower fuel consumption
- Longer maintenance intervals
- Lower emissions

Efficiency Flexibility Comfort

- 1 Main Diesel Engines
- 2 Gearbox
- 3 Gensets
- 4 Switchboard
- 5 Energy Storage
- 6 Electric Motor

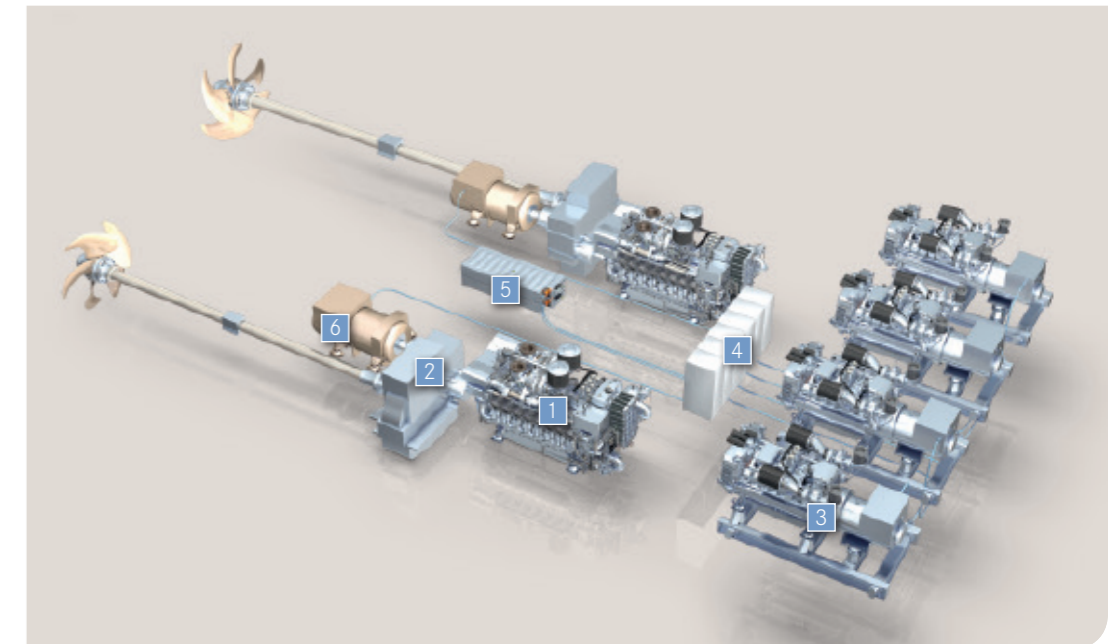

Emergency Gensets

Power for your safety.

Even in hazardous situations at sea, MTU emergency gensets enable you to stay relaxed and in control.

MTU's autonomous back-up system generates electrical power in emergencies or in the event of power failure. With MTU, you always stay in control, giving your crew the time and space to fix the problem on-board.

Safety

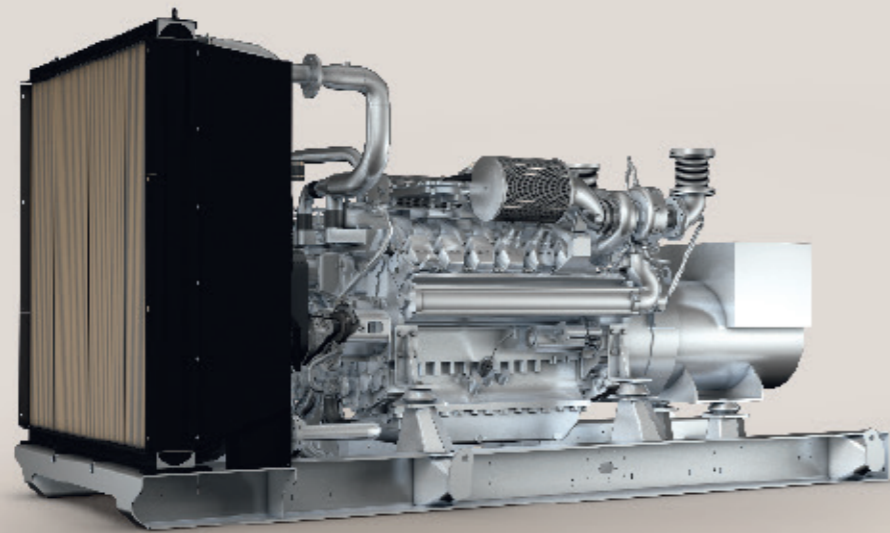

Variable Speed Gensets

Power for your flexibility.

Do you want a flexible system with forward-looking technology that gives you the scope to operate as efficiently as possible? Variable speed gensets from MTU make that possible.

Variable speed gensets provide the highest degree of flexibility and best power density. MTU's patented Superior System Controller (SSC) determines the best operating point in the engine performance map in relation to the electrical power demand. The compact design of variable speed gensets provides you with additional space and your fuel and maintenance costs will be lower throughout the entire service life.

Your benefits are:

- Higher maximum power than on constant speed gensets
- Lower noise signature*
- Longer maintenance intervals (up to 20%)*
- Less maintenance costs (savings up to 19%)*

*significantly depending on project-specific operation (efficiency gain depends on system losses and generator operating curve)

Flexibility

Efficiency



- 1 Gensets
- 2 Switchboard
- 3 Electric Motor
- 4 Potential genset saving due to higher power output

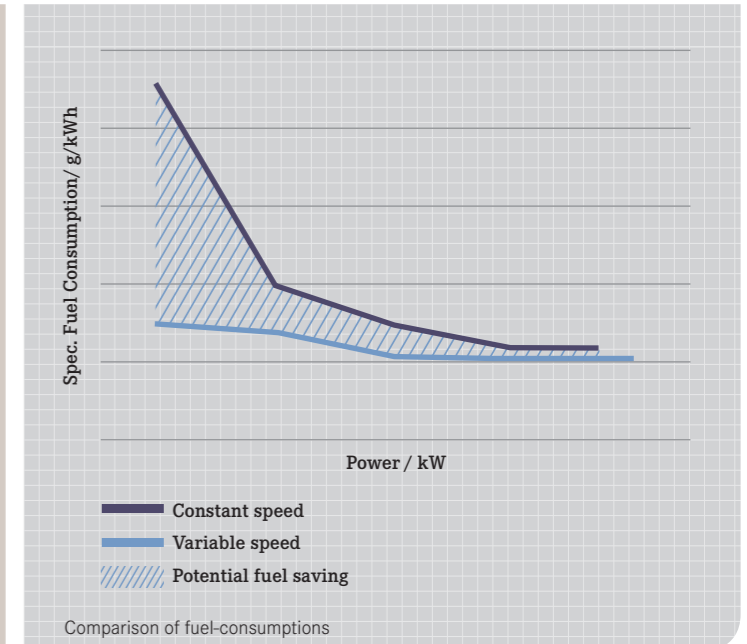
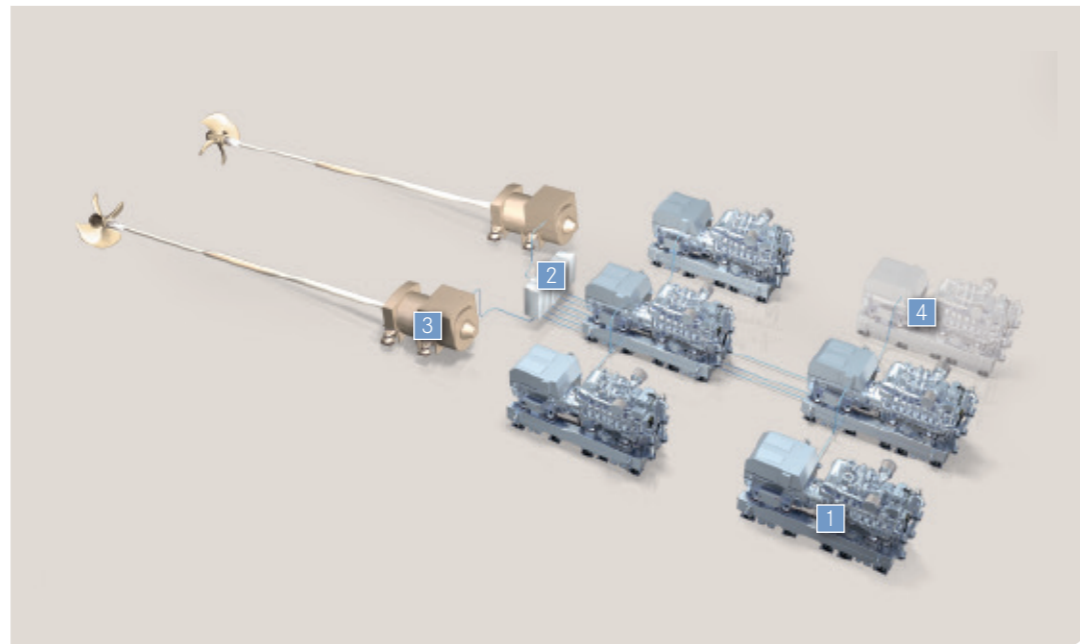

Proven solutions for high demands.

MTU advanced gensets are pre-engineered and based on a proven design. Depending on your individual requirements, you can choose between a constant or variable speed configuration.

The characteristic feature of this genset is its Double-Resilient Mounting System, which reduces noise emissions and makes a noticeable difference to your comfort on-board. The high-quality paint-finish and overall look of the genset perfectly matches your yacht environment.

Pre-installation of components such as filters directly on the base frame reduces installation work and space, allowing easy connection to the yacht's interfaces and fast commissioning. All gensets are fully pre-tested at MTU's test facilities with respect to technical guarantees so that component function and readiness for operation on-board are proven.

Overall, MTU advanced gensets provide the most attractive cost/performance ratio on the market. Both, engine and generator will be operated and monitored by the MTU **genoline** System including a Local Operating Panel (LOP).

Your benefits are:

- Attractive cost/performance ratio
- Proven design and short term availability
- Standardized resilient mounting system for advanced acoustic requirements
- Pre-installed main components for easy installation

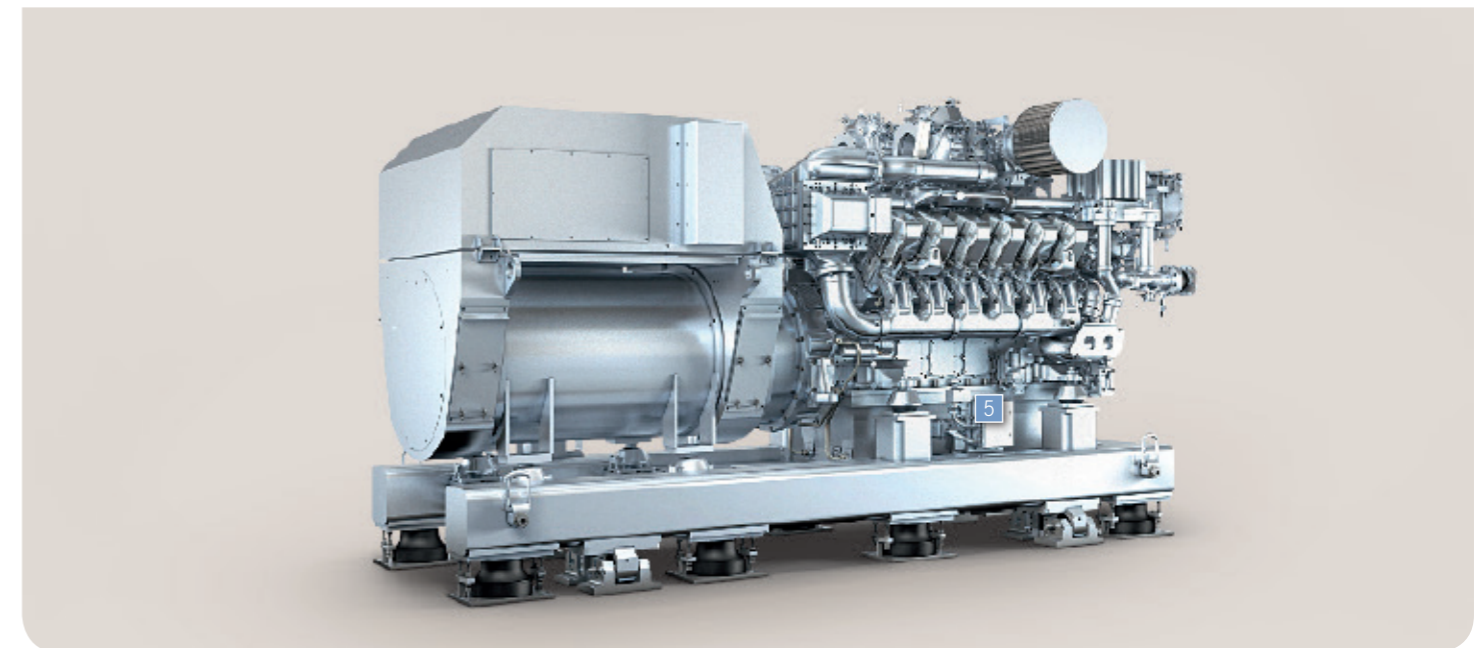
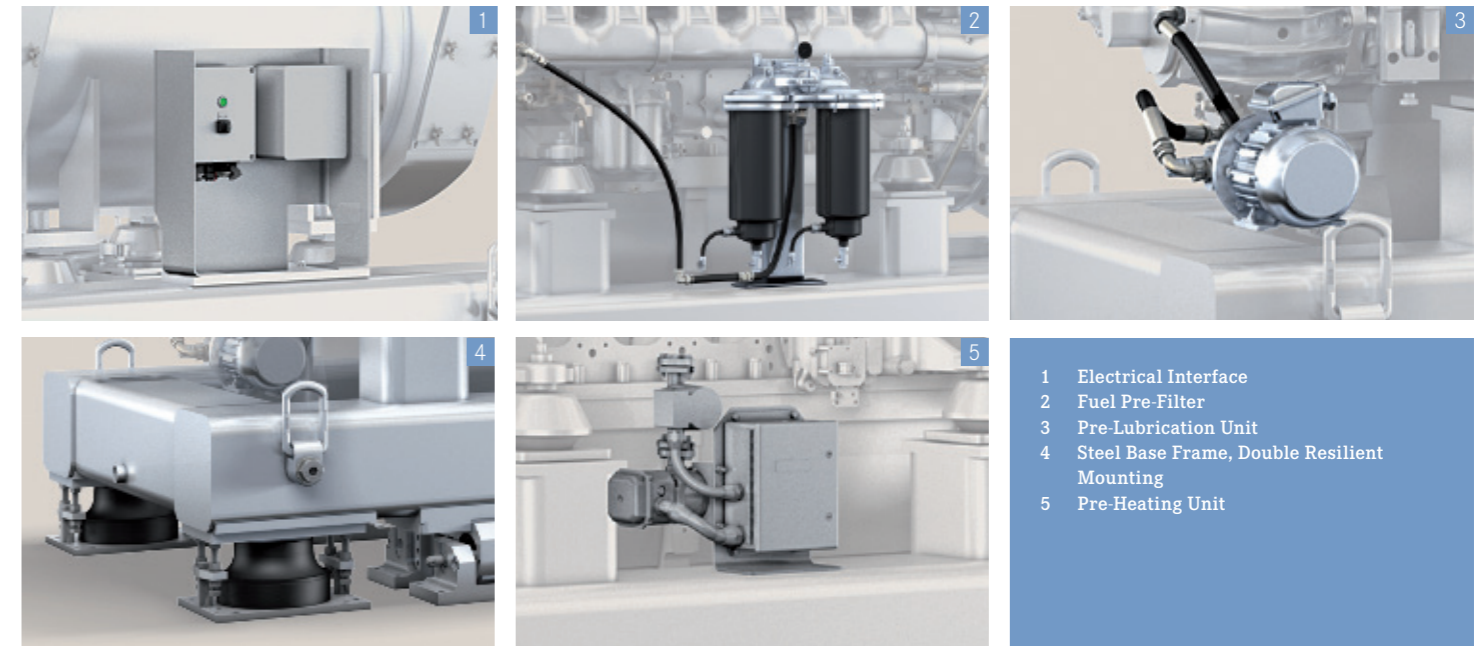
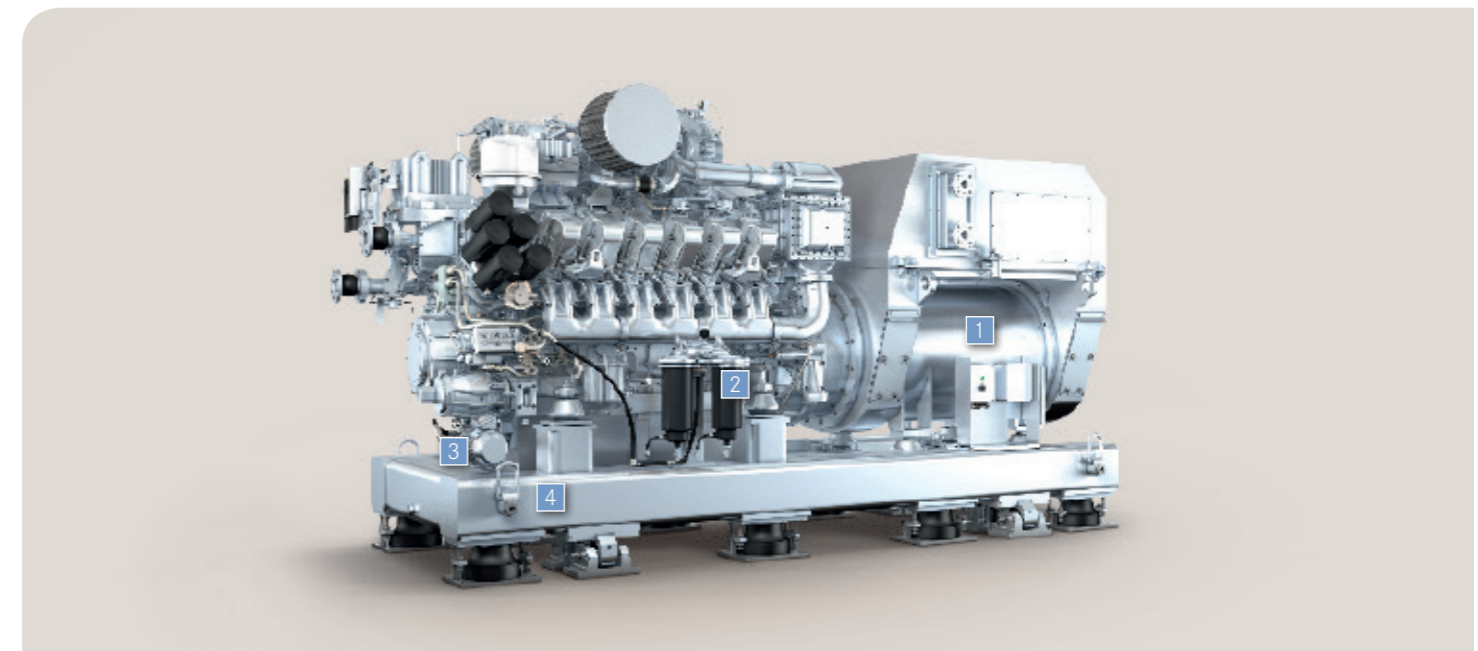

MTU Premium Gensets

Sophisticated solutions for high-end demands.

MTU's premium gensets are our sophisticated solution that perfectly matches the high-end demands of your tailor made yacht.

The MTU premium genset is the product of engineering expertise and the use of highly developed components. Premium gensets can be individually configured to provide effective solutions to the most challenging demands. If required they can also be 100% customized. MTU's premium gensets feature special technologies: the Double-Resilient Mounting System with a base frame filled with polymer concrete, fully integrated oil, fuel and water systems, an integrated lube oil tank including all pumps, check valves and sensors and the Common Interface Connection Plate for easy 'plug-and-play' installation.

Of course MTU premium gensets are available in constant or variable speed configuration. The MTU **genoline** System including a Local Operating Panel (LOP) operate both, engine and generator.

Your benefits are:

- Implementing individual needs to the genset design up to fully tailor made gensets are possible
- Customized resilient mounting system for premium acoustic requirements
- High-end finishing and painting
- All components are pre-installed for easiest installation via a central media plate

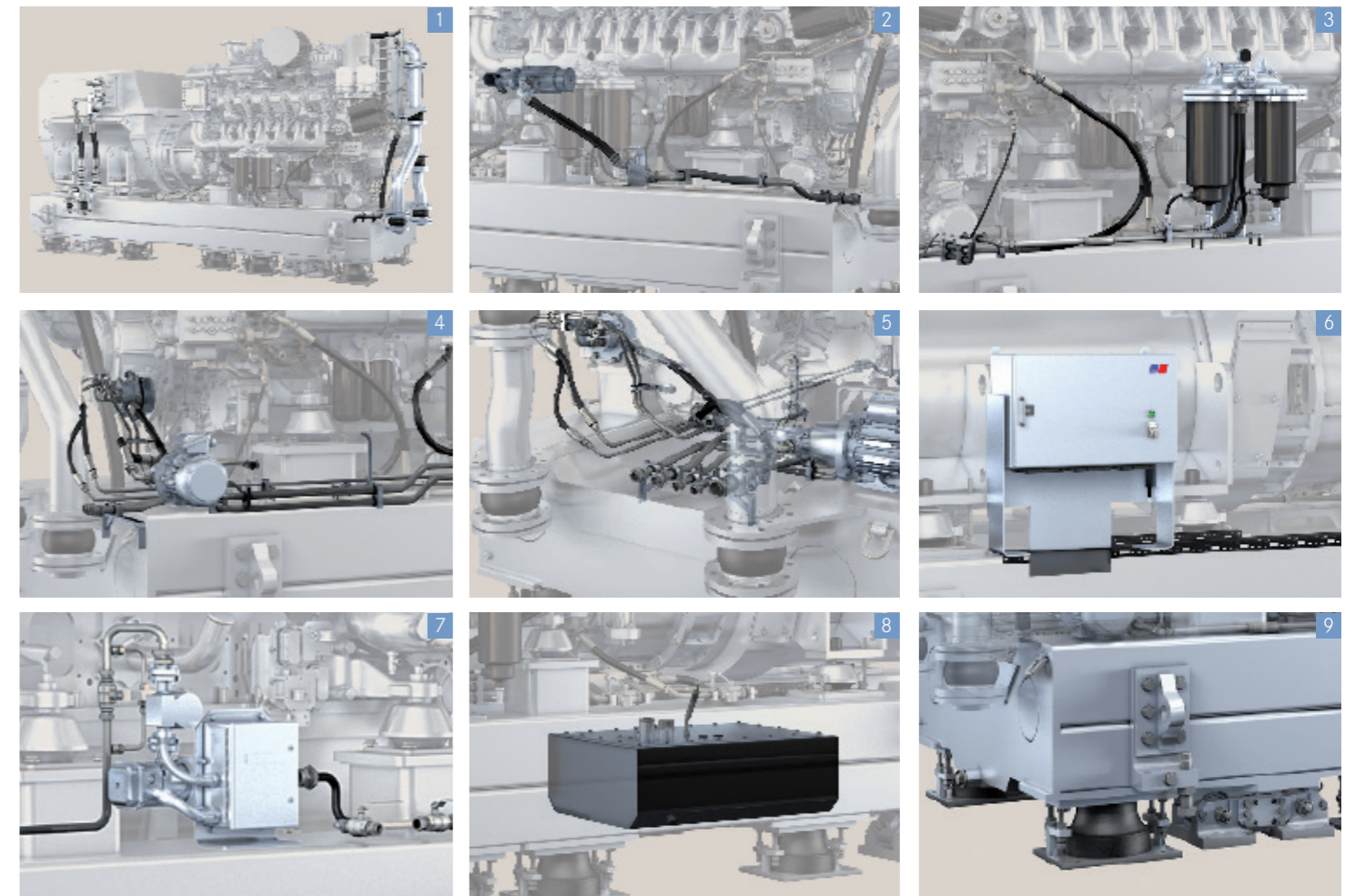
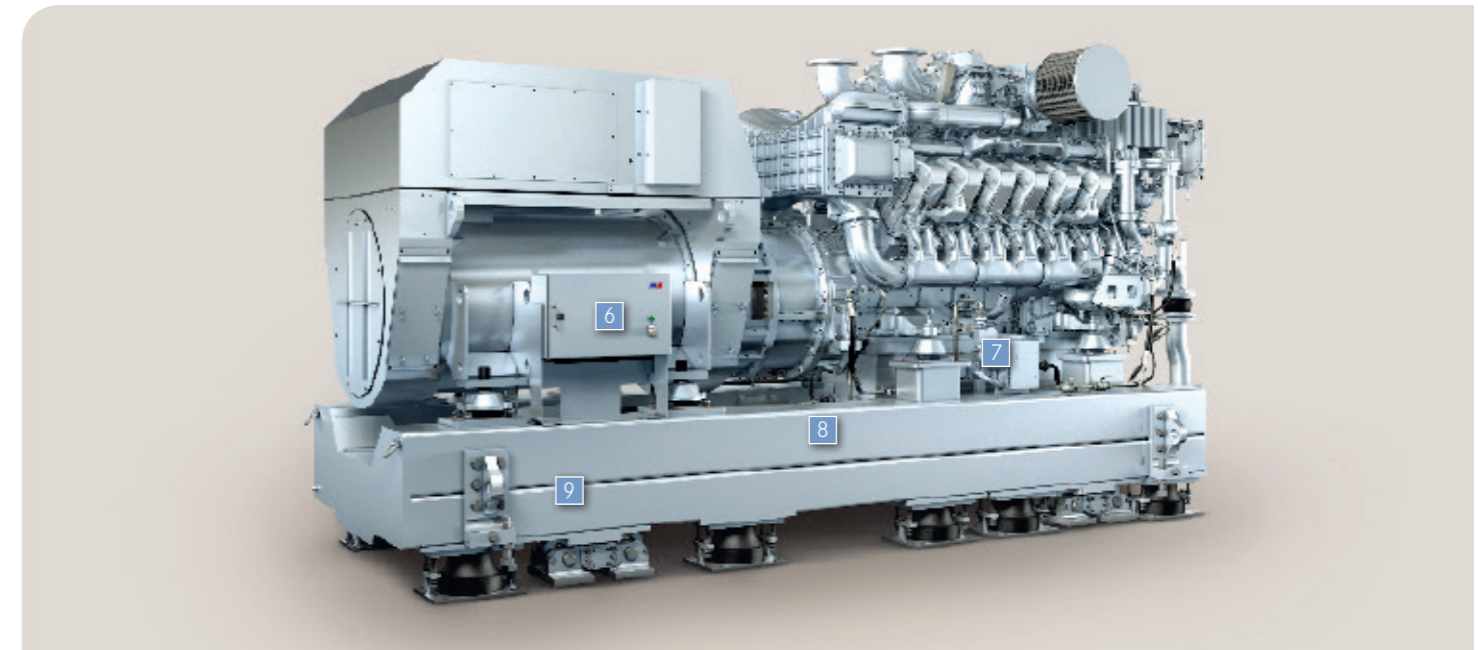

- 1 Seawater Piping
- 2 Air Starter
- 3 Fuel Pre-Filter
- 4 Pre-Lubrication Unit
- 5 Central Interface Mediaplate
- 6 Electrical Interface
- 7 Pre-Heating Unit
- 8 Integrated Oil Tank
- 9 Double Resilient Mounting System with Polymer Concrete-Filled Base Frame

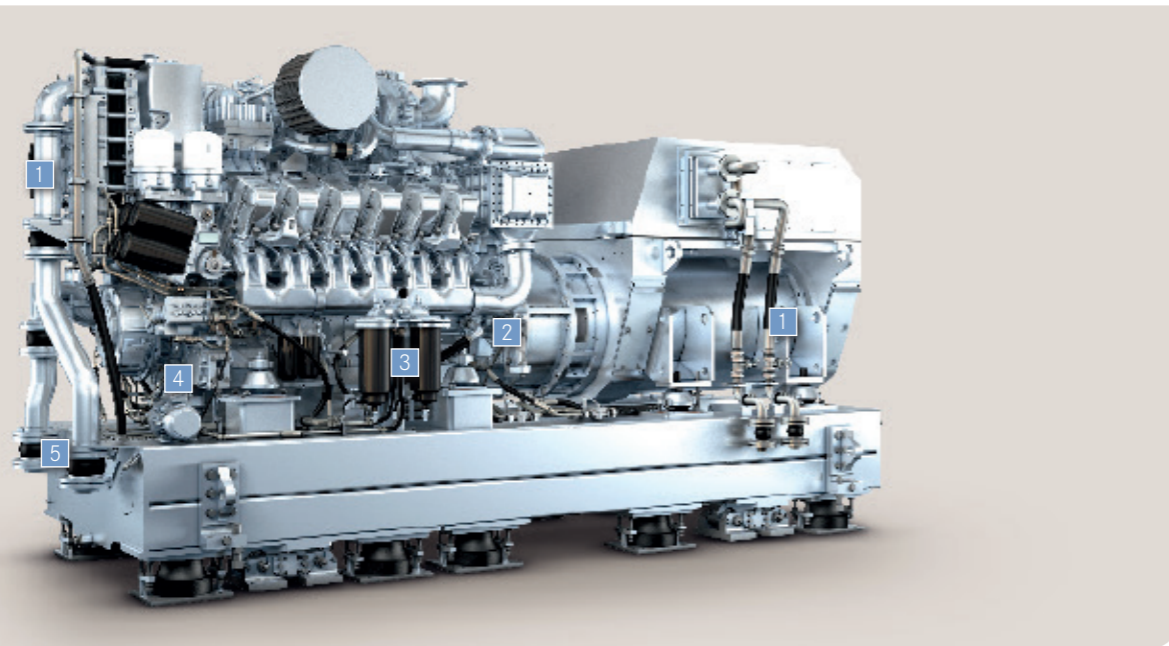



MTU Premium Gensets

Sound enclosure – plus top performance.

The sound-attenuated premium genset from MTU: the ultimate luxury in power generation.

MTU premium gensets housed in sound enclosures offer the ultimate technical benefits in terms of low noise and low vibration.

Air intake silencers, for example, are integrated into the sound enclosures, making the engine room and yacht in general very quiet. As a result, acoustic insulation of the engine room itself is easier and less expensive, and acoustically sensitive areas can be located close to it. Systems such as fire-extinguishing units are also integrated into the sound enclosures, making the gensets very convenient to install in the engine room and improving safety in the event of fire.

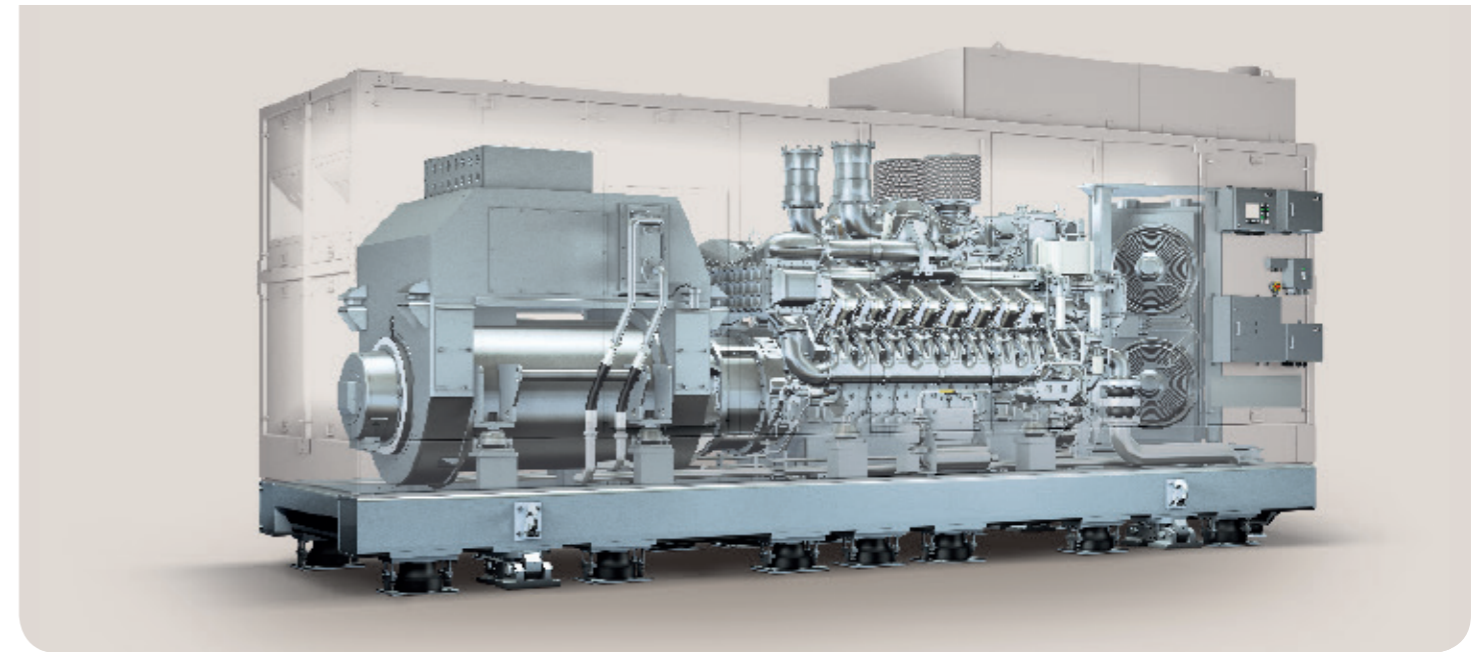

Your benefits at a glance.

MTU supplies constant or variable speed gensets with up to 3,480 kW output for onboard power, diesel-electric and hybrid propulsion as well as emergency power.

We offer multiple ratings for meeting your yacht's electrical power requirements. MTU gensets for yacht applications are specifically designed for comfort, reliability, efficiency, flexibility and safety. You can be sure that all components will work together seamlessly. Whether you choose an advanced or premium genset, you gain the benefits of a complete system from a single trusted source that meets MTU's high quality standards.

Your benefits are:

- Power outputs from **5 to 3,480 kW** to cover all marine requirements.
- Gensets based on proven **Series 2000 and 4000 engines** – of which **over 60,000 have been sold worldwide**.
- **Various** available **configurations**, including full customization, tailored to meet your specific needs.
- Overall **system responsibility** by MTU based on its engineering and development expertise.
- **Outstanding acoustic** optimization for best-in-class comfort (**noise and vibration** levels can be **contractually guaranteed**, with all values proven on MTU test benches to minimize risk).
- Featuring special **plug-and-play technology** such as media plate and integrated piping for very easy installation.
- Backed up by **decades of experience** in customer-specific solutions.
- Proven by the **highest number of references** in yacht industry.
- All MTU gensets are **classifiable** according to e.g. DNV-GL, LRS.
- Gensets with **high quality finishing** and painting dedicated for the yacht market.



MTU Friedrichshafen GmbH | MTU Asia Pte Ltd | MTU America Inc.
Rolls-Royce Power Systems Companies

www.mtu-online.com